

# Differential pressure measuring instrument

## testo 521 – Precise Pitot tube measurement

---

Temperature-compensated differential pressure sensor in instrument

---

Additional 2 probe inputs for the connection of further probes for the measurement of pressure and temperature

---

Direct calculation of flow velocity and volume flow

---

Direct zeroing of display value from pressure probes

---

Display of Hold-, max. and min. values

---

Easy data storage by measurement site as well as analysis, archiving and documentation via optional PC software

---

Point and timed mean value calculation

---



hPa

°C

testo 521-1/-2/-3 are highly accurate differential pressure measuring instruments with an internal sensor. The versionstesto 521-1 and testo 521-2 both have a measuring range from 0 to 100 hPa, however they are available in two accuracy classes:

- testo 521-1: accuracy 0.2 % of final value
- testo 521-2: accuracy 0.1 % of final value

testo 521-1 and testo 521-2 are optimally suited to checks on extraction systems and ventilators and for the monitoring of pressure drop at filters. In combination with a Pitot tube, the internal sensor measures flow velocities from 5 to 100 m/s. The instrument additionally has two probe inputs for the connection of further probes for the measurement of

pressure and temperature. A large selection of probes is available for this purpose.

testo 521-3 has a measuring range of 0 to 2.5 hPa and records even the smallest pressure differences without difficulty. Its high accuracy and a resolution of 0.1 Pa make it ideal for differential pressure measurements in cleanrooms. In combination with the Pitot tube, the internal sensor measures flow velocities from 1 to 20 m/s. The testo 521-3 is also equipped with two probe inputs for the connection of further probes for the measurement of pressure and temperature.

## Differential pressure measuring instrument

### testo 521-1

testo 521, differential pressure measuring instrument with measuring range 0 to 100 hPa and 0.2 hPa accuracy, incl. calibration protocol and batteries

Part no. 0560 5210



### testo 521-2

testo 521, differential pressure measuring instrument with measuring range 0 to 100 hPa and 0.1 hPa accuracy, incl. calibration protocol and batteries

Part no. 0560 5211

### testo 521-3

testo 521, differential pressure measuring instrument with measuring range 0 to 2.5 hPa, incl. calibration protocol and batteries

Part no. 0560 5213

#### testo 521-1/-2 with internal sensor 0 to 100 hPa / 0.1 %

testo 521-1/-2 is equipped for accurate differential pressure measurements in the VAC sector, for example pressure drops in filters, inspections on ventilators and suction systems. Use testo 521-1/-2 for Pitot tube measurements in the range 5 to 100 m/s.

#### testo 521-3 with internal sensor 0 to 2.5 hPa

Even the smallest differential pressures up to 2.5 hPa are measured using testo 521-3. A high accuracy level and a resolution of 0.1 Pa make the instrument ideal for measurements in cleanrooms or for flue draught inspections. Use testo 521-3 for accurate measurements during Pitot tube measurements in the range 1 to 20 m/s.

## Advantages testo 521

- Built-in differential pressure probe
- 2 user defined probe sockets for pressure and temperature
- Wide selection of probes
- Documentation on site
- Easy data management via PC
- 2 line display with text menu guide
- Display light
- Mains socket/fast battery recharging
- Fast-action coupling connections M8x0.5

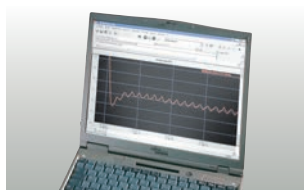

Easy data management via PC



Inspection of transmitters with 4 to 20 mA interface



2 user defined probe sockets for pressure and temperature

## Further advantages testo 521

### Wide selection of probes

The differential pressure sensor is integrated into testo 521. Up to two additional probes can be connected through user-defined probe sockets.

- Differential pressure probes to 2000 hPa
- Absolute pressure probes to 2000 hPa
- Relative pressure probes to 400 bar
- Temperature probes from -200 to +1250 °C
- Probes for measuring current/voltage

### Advantages while measuring

- The short-text menu facilitates the handling vastly.
- Two measurement channels are displayed in the large two-lined LED-display; switching between the calculated measurement parameters is done by way of the arrow buttons.
- Zeroing of the relative and differential pressure is done by pressing the P=O button.
- When measuring pressure, the following units can be selected: mbar, hPa, bar, Pa, kPa, inH<sub>2</sub>O, mmH<sub>2</sub>O, torr and psi.
- Button for Hold, max, min and mean values.
- Hands-free: TopSafe (impact protection) including carrier strap and magnet disc as useful accessories.

### Documentation on site

- Measurement protocols can be printed on site. No awkward cables required on account of the infrared interface.
- Long-term legible thermal paper ensures that measurement data documentation can be stored for up to 10 years.

### Pitot tube measurement, Pitot tube factor 1.00

With the built-in pressure sensor with an accuracy of 0.1 % of the full-scale value, the testo 521-2 enables precise measurement results in the range of 5 to 100 m/s:

Accuracy at 5 m/s:	0.32 m/s
Accuracy at 10 m/s:	0.09 m/s
Accuracy at 50 m/s:	0.05 m/s

### Long-term monitoring also during dynamic measurement (only testo 521-1/-2)

- Measurement data can be saved separately or as a measurement series. The measurement rate (0.04 seconds, 1 second to 24 hours) and the number of values to be saved are freely selectable. The maximum memory size is 100 KB (25000 readings).
- Dynamic measurements can be saved in the instrument at a measurement rate of 0.04 seconds. Here you have the option of displaying the values every second. For large quantities of data, activate the online measurement via a PC.

### Easy data management via PC

- The saved measurement data can be easily analysed and processed using the software available.
- Readings are taken by the instrument and can be depicted online by the software.

In the lower flow range of 1 to 12 m/s, high accuracy can be reached by connecting the 100 Pa-probe. The double membrane technology completely eliminates positional dependences. Changes in position do not influence the measurement result:

Accuracy at 2 m/s:	0.1 m/s
--------------------	---------

# Technical data

## General technical data testo 521-1/-2/-3

Storage temperature	-20 to +70 °C	Connection	Hose: inner Ø 4 mm outer Ø 6 mm
Operating temperature	0 to +50 °C	Display	LCD display with symbol, 7 segment display and point matrix
Power supply	Battery/Rechargeable battery, Mains unit 12 V	Updating rate in display	2x per second, in fast measurement 4x per second
Battery type	9 V (6LR61)	Measuring rate	from 0.04 seconds
Battery life	Continuous operation w/ internal pressure sensor: 30 h With rech. battery: 10 h With carbon battery: 18 h	PC	RS232 interface
Weight	300 g	Other features	Mains connection and battery recharging in instrument Automatic recognition of all connected probes 9 measurement units selectable: mbar, hPa, bar, Pa, kPa, inH <sub>2</sub> O, mmH <sub>2</sub> O, torr, psi
Dimensions	219 x 68 x 50 mm	Warranty	2 years
Housing material	ABS		
Memory	100 kB (corresponds to approx. 25000 readings)		

## Sensor types

	Piezoresistive pressure sensor	Piezoresistive pressure sensor For external pressure probes	Ceramic sensor for external pressure probes	NTC	Type K (NiCr-Ni)
Measuring range	0 ... 100 hPa (testo 521-1/-2) 0 to 2.5 hPa (testo 521-3**)	0 to 2000 hPa	-1 to 400 bar	-40 to +150 °C	-200 to +1370 °C
Accuracy ±1 digit*	±0.2 % of fsv (testo 521-1) ±0.1 % of fsv (testo 521-2) ±0.5 Pa (0 to 20 Pa) ±(0.5 Pa ±0.5% of mv) (20.1 to 250 Pa) (testo 521-3**)	±0.1 % of mv	±0.2 % of fsv	±0.2 °C (-10 to +50 °C) ±0.4 °C (remaining range)	±0.4 °C (-100 to +200 °C) ±1 °C (remaining range)
Resolution	0.01 hPa (testo 521-1/-2) 0.1 Pa (testo 521-3**)	0.1 Pa (0638 1347) 0.001 hPa (0638 1447) 0.01 hPa (0638 1547) 0.1 hPa (0638 1847 / 0638 1647)	0.01 bar	0.1 °C	0.1 °C
Static pressure	1000 hPa (abs) (testo 521-1/-2) 1000 hPa (abs) (testo 521-3**)				
Overload	300 hPa (testo 521-1/-2) 50 hPa (testo 521-3**)				
Zeroing	to 2.5 hPa (testo 521-1/-2) to 0.5 hPa (testo 521-3**)				





\*Accuracy information applies only to instrument without probes connected

\*\*Sensor is not suitable for long-term measurements

# Accessories



<b>Additional accessories and spare parts</b>	<b>Part no.</b>	
Desk-top power supply with international connection options	0554 1143	
9V rech. battery for instrument, instead of battery	0515 0025	
Recharger for 9V rechargeable battery, for external recharging of 0515 0025 battery	0554 0025	
<b>Transport and Protection</b>		
TopSafe (protection case), incl. carrier strap, bench stand and magnet. Protects instrument from dust, impact, scratches	0516 0446	
<b>Printer and Accessories</b>		
Testo fast printer IrDA with wireless infrared interface; 1 roll thermal paper; 4 AA batteries, for printing out measurements on site	0554 0549	
External fast charger for 1-4 AA rech. batteries, incl. 4 Ni-MH rech. batteries with individual cell charging and charge control display, incl. impulse trickle charging, integrated discharge function, with built-in international mains plug, 100-240 V, 300 mA, 50/60 Hz	0554 0610	
Spare thermal paper for printer (6 rolls), permanent ink, measurement data documentation legible for up to 10 years	0554 0568	
<b>Software and Accessories</b>		
ComSoft Professional, Pro software incl. data archiving	0554 1704	
RS232 cable, connects instrument to PC (1.8 m) for data transfer	0409 0178	
<b>Calibration Certificates</b>		
DAkkS calibration certificate/Pressure, Differential pressure, accuracy < 0.1 (% of full scale value)	0520 0205	
DAkkS calibration certificate/pressure, differential pressure, accuracy 0.1 to 0.6 (% of full-scale value)	0520 0215	
DAkkS calibration certificate/pressure, differential pressure, accuracy > 0.6 (% of full-scale value)	0520 0225	
ISO calibration certificate/Pressure, Differential pressure, accuracy < 0.1 (% of full scale value)	0520 0035	
ISO calibration certificate pressure, accuracy 0.1 to 0.6 (% of fsv), 5 points distributed over meas. range	0520 0025	
ISO calibration certificate pressure, accuracy > 0.6 (% of fsv)	0520 0005	
ISO calibration certificate/Pressure, Differential pressure, accuracy > 0.1 (% of fsv), for testo 521-2	0520 0405	
ISO calibration certificate/temperature, for air/immersion probes, calibration points -18°C; 0°C; +60°C	0520 0001	
ISO calibration certificate/temperature, meas. instr. with air/immersion probe; cal. points 0°C; +150°C; +300°C	0520 0021	
ISO calibration certificate/temperature, meas. instr. with surface probe; calibration points +60°C; +120°C; +180°C	0520 0071	
DAkkS calibration certificate/temperature, meas. instr. with air/immersion probe; calibration points -20 °C; 0 °C; +60 °C	0520 0211	
DAkkS calibration certificate/temperature, contact surface temperature probes; calibration points +100°C; +200°C; +300°C	0520 0271	
ISO calibration certificate/electrical	0520 1000	
<b>Probe accessories</b>		
Cable, 1.5 m long, connects probe with plug-in head to meas. instrument, PUR coating material	0430 0143	
Cable, 5 m long, connects probe with plug-in head to measuring instrument, PUR coating material	0430 0145	
Connection hose; silicone; 5 m long; max. load 700 hPa (mbar)	0554 0440	
Connection cable, 2.5 m long, for pressure probes 0638 1741/1841/1941/2041/2141	0409 0202	
Adapter to connect NiCr-Ni thermocouples and probes with open wire ends	0600 1693	

# Probes

Probe type	Illustration	Measuring range	Accuracy	Overload	Static pressure	Zeroing	Part no.
<b>Differential pressure probe</b>							
Precision pressure probe, 100 Pa, in robust metal housing with impact protection, incl. magnet for fast attachment, to measure differential pressure and flow speeds (in combination with Pitot tube)		0 to +100 Pa	±(0.3 Pa ±0.5% of mv)	50 hPa	100 hPa	to 20 Pa	0638 1347
Pressure probe, 10 hPa, in robust metal housing with impact protection incl. magnet for fast attachment, to measure differential pressure and flow speeds (in combination with Pitot tube)		0 to +10 hPa	±0.03 hPa	50 hPa	1000 hPa	to 0.4 hPa	0638 1447
Pressure probe, 100 hPa, in robust metal housing with impact protection, incl. magnet for fast attachment, to measure differential pressure and flow speeds (in combination with Pitot tube)		0 to +100 hPa	±0.5% of mv (+20 to +100 hPa) ±0.1 hPa (0 to +20 hPa)	300 hPa	1000 hPa	to 4 hPa	0638 1547
Pressure probe, 1000 hPa, measures differential pressure, in robust metal housing with impact protection, incl. quick-closing coupling (M8 x 0.5), magnet for fast attachment		0 to +1000 hPa	±1 hPa (0 to 200 hPa) ±0.5% of mv (200 to 1000 hPa)	2000 hPa	1000 hPa	to 20 hPa	0638 1647
<b>Absolute pressure probe</b>							
Pressure probe, 2000 hPa, measures absolute pressure, in robust metal housing with impact protection, incl. quick-closing coupling (M8 x 0.5), magnet for fast attachment		0 to +2000 hPa	±5 hPa (0 to +2000 hPa)	4000 hPa	-	-	0638 1847

Operating temperature: 0 to +50 °C (compensated)  
 Connection: Plug-in head. connection cable 0430 0143 or 0430 0145 required

# Probes

Probe type	Illustration	Measuring range	Accuracy	Overload	Zeroing	Part no.
<b>Relative pressure probe (media compatible)</b>						
Low pressure probe, refrigerant-proof stainless steel, up to 10 bar		-1 to +10 bar	±1% of fsv	25 bar	to 0.1 bar	0638 1741
High pressure probe, refrigerant-proof stainless steel, up to 30 bar		-1 to +30 bar	±1% of fsv	120 bar	to 0.3 bar	0638 1841

Operating temperature: -40 to +100 °C; 0 to +70 °C (compensated)

Connection: Plug-in head, connection cable 0409 0202 required  
screw-in thread 7/16" UNF

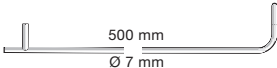
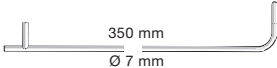
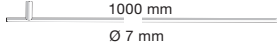
Probe type	Illustration	Operating temperature	Part no.
<b>Pitot tubes</b>			
Pitot tube, 500 mm long, Ø 7 mm, stainless steel, for measuring flow velocity In conjunction with 0638 1347 / 0638 1447 / 0638 1547 pressure probes or testo 521, testo 435-3, testo 435-4 and testo 480 with internal sensor		0 to +600 °C	0635 2045
Pitot tube, 350 mm long, Ø 7 mm, stainless steel, for measuring flow velocity In conjunction with 0638 1347 / 0638 1447 / 0638 1547 pressure probes or testo 521, testo 435-3, testo 435-4 and testo 480 with internal sensor		0 to +600 °C	0635 2145
Pitot tube, 1000 mm long, stainless steel, for measuring flow velocity		0 to +600 °C	0635 2345

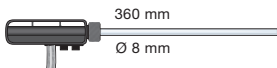
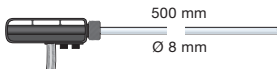
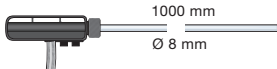
Probe type	Illustration	Measuring range	Probe type	Part no.
<b>Straight Pitot tubes</b>				
Pitot tube, stainless steel, 360 mm long, measures velocity with temperature, for pressure probes 0638 1345/..1445/..1545		-40 to +600 °C	Type K (NiCr-Ni)	0635 2040
Pitot tube, stainless steel, 500 mm long, measures velocity with temperature, for pressure probes 0638 1345/..1445/..1545		-40 to +600 °C	Type K (NiCr-Ni)	0635 2140
Pitot tube, stainless steel, 1000 mm long, measures velocity with temperature, for pressure probes 0638 1345/..1445/..1545		-40 to +600 °C	Type K (NiCr-Ni)	0635 2240

# Probes

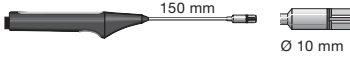
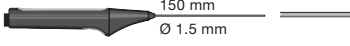
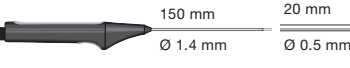
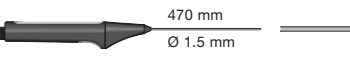
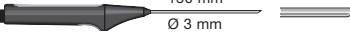
Probe type	Dimensions Probe shaft/probe shaft tip	Measuring range	Accuracy	t <sub>99</sub>	Part no.
<b>Temperature probes</b>					
Quick-action surface probe**		-200 to +300 °C	Class 2*	3 s	0604 0194
Super quick-action immersion/penetration probe for measurements in liquids **		-200 to +600 °C	Class 1*	1 s	0604 0493
Super quick-action immersion/penetration probe for measurements in gases and liquids with a low-mass tip**		-200 to +600 °C	Class 1*	1 s	0604 9794
Super quick-action immersion/penetration probe for high temperatures **		-200 to +1100 °C	Class 1*	1 s	0604 0593
Fast response immersion/penetration probe **		-200 to +400 °C	Class 1*	3 s	0604 0293

\*According to standard EN 60584-2, the accuracy of Class 1/2 refers to -40 to +1000/+1200 °C  
 \*\*Connection: Plug-in head. connection cable 0430 0143 or 0430 0145 required

		Part no.
Adapter to connect NiCr-Ni thermocouples and probes with open wire ends		0600 1693

0981 9814/dk/A/11.2014

Subject to change without notice.



